

■ 特長 FEATURES

- ブラシレス、金属遊星ギヤタイプ
- 制御回路内蔵モデル
- Brushless DC motor, Metal planetary gear type
- Model with built-in control circuit

RoHS 指令対応 RoHS compliant



■ 型式表示 PART NUMBER DESIGNATION

**LB16MG - 060 - AB - 00**

Series name

Rated voltage

A : 6 VDC B : 12 VDC

Gear ratio

015 : 1/15 030 : 1/30 060 : 1/60 120 : 1/120  
240 : 1/240 300 : 1/300 500 : 1/500 650 : 1/650

■ 型式および仕様一覧表 LIST OF PART NUMBERS & SPECIFICATIONS

型式名 Model	定格電圧 Rated voltage [V]	減速比 Gear ratio		定格(推奨)負荷 Rated (recommended) load			無負荷 No-load		起動 Stall		許容トルク Allowable torque [mNm]	電流制限 Current limit [mA]	最大出力 Maximum output power [W]	質量 Mass [g]
		呼称 Nominal	[1/x]	トルク Torque [mNm]	回転数 Speed [min <sup>-1</sup> ]	電流 Current [mA]	回転数 Speed [min <sup>-1</sup> ]	電流 Current [mA]	トルク Torque [mNm]	電流 Current [mA]				
LB16MG-015-AB-00	12	15	16	5	761	163	812	100	80	1100	8	800	8	28
LB16MG-030-AB-00		30	28.5	10	423	171	456	100	140	1100	15		15	
LB16MG-060-AB-00		60	64	20	189	157	200	100	350	1100	25		25	
LB16MG-120-AB-00		120	107.2	30	110	146	115	100	650	1100	45		45	38
LB16MG-240-AB-00		240	256	60	47	167	50	100	900	1100	80		80	
LB16MG-300-AB-00		300	304	100	39	183	42	100	1200	1100	150		150	
LB16MG-500-AB-00		500	509	150	22.2	175	24	100	2000	1100	200		200	200
LB16MG-650-AB-00		650	643	200	18.3	183	20	100	2400	1100	250		250	250

■ 外形寸法図 OUTLINE DIMENSIONS

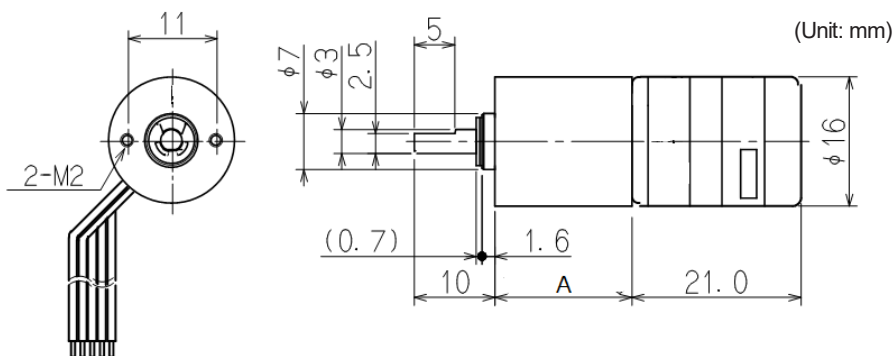

Mark A

Gear ratio	1/15	1/30	1/60	1/120	1/240	1/300	1/500	1/650
A	14		17		20			

**■ PERFORMANCE CURVES**

(Figures in the table are typical values under rated operating condition.)

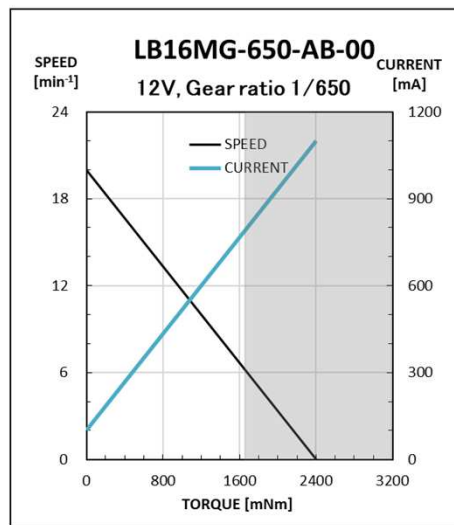
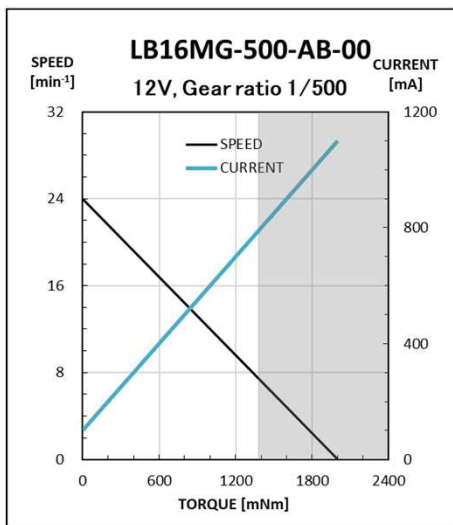
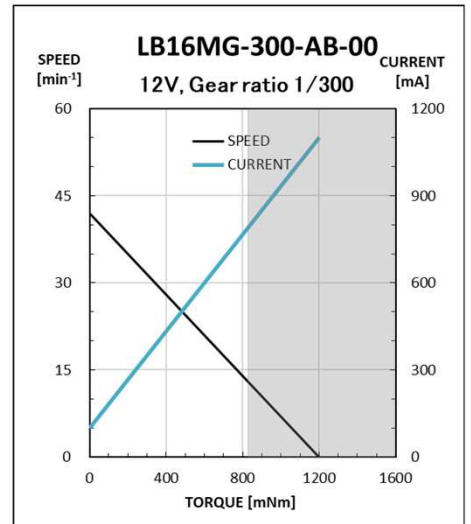
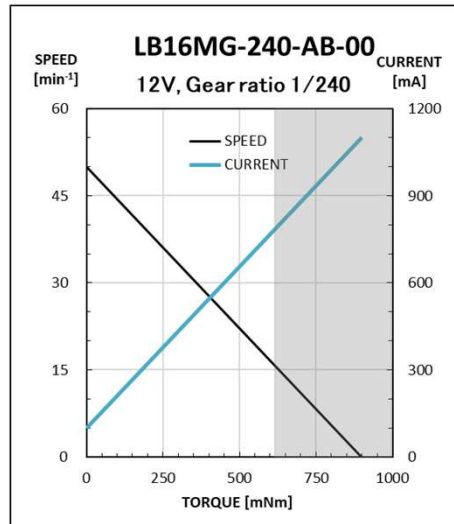
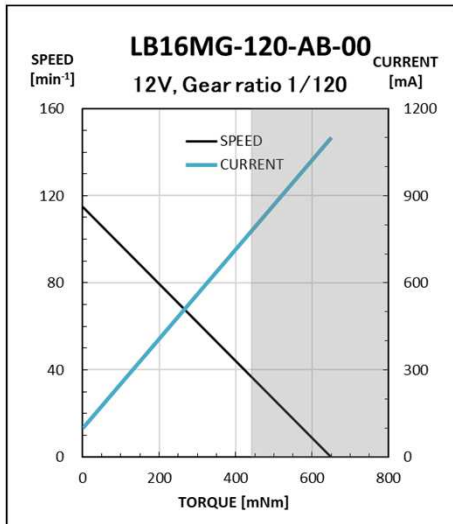
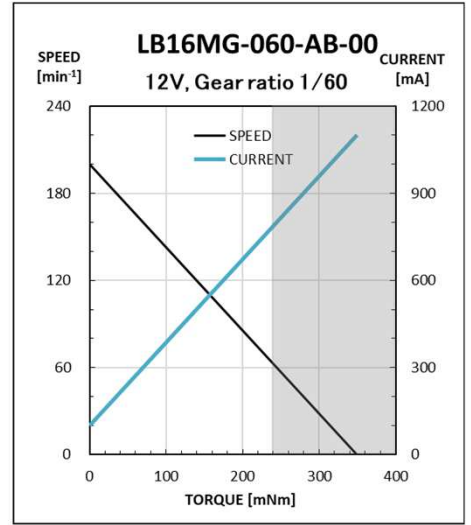
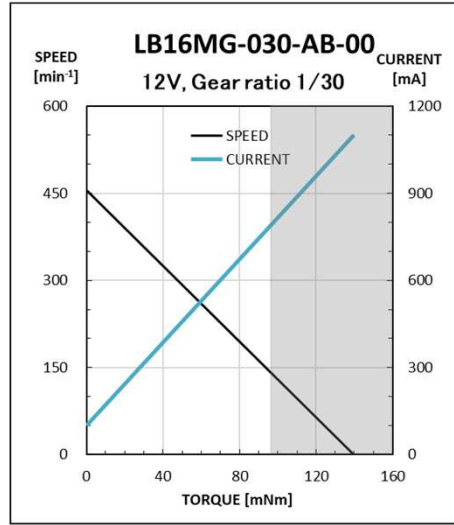
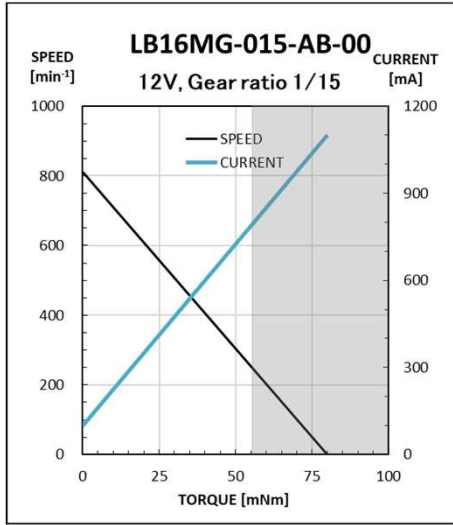

**NOTE)**

特性グラフに灰色で示す領域は電流制限値800mAを超えるため、この負荷領域で使用することはできません。

The gray part of the characteristic graph exceeds the current limit of 800mA and cannot be used in this load range.